

Microwave Cable Products

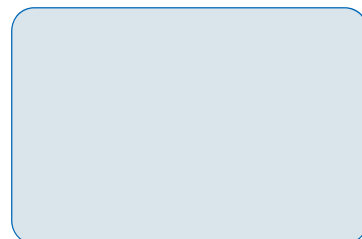
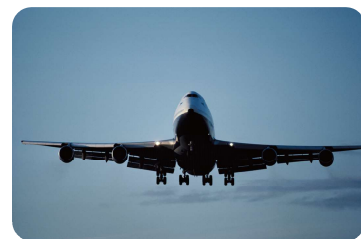
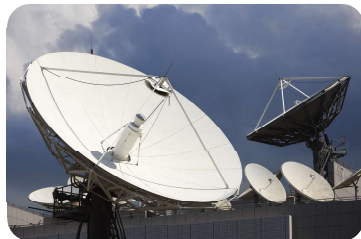
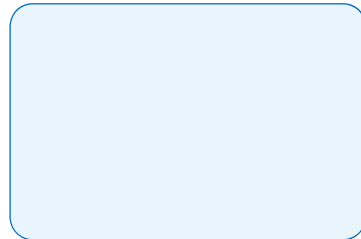
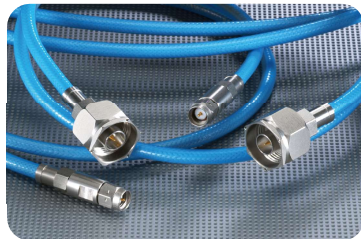
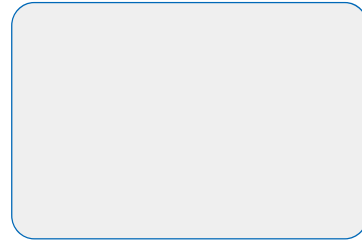

MaxGain®

Features & Benefits:

- Lowest Insertion Loss Available, DC-50 GHz
- Ultra Stable Insertion Loss, Phase and VSWR with Flexing
- Excellent Phase Tracking Performance with wide Temperature (-55°C to +150°C)
- Extremely Flexible, Low Minimum Bend Radius
- Superior Shielding Effectiveness (>90 dB)
- Typical VSWR for assemblies is <1.40:1 at maximum frequencies

Flex Durability	Very Good
Attenuation	Very Low
Phase Temp. Stability	Good
Connector Availability	Good

MaxGain® ultra low loss, flexible Microwave Coaxial Cable and a full range of passivated stainless steel connectors are available as fully tested custom cable assemblies or for assembly by skilled assembly facilities. The assembly of the connectors to the cable is accomplished by soldering to the inner and outer conductor resulting in excellent mechanical and electrical performance, but is only recommended for installation by skilled technicians in a factory environment. Alternatively, Times can provide completed assemblies to your specifications.



MaxGain® assemblies are used for general applications in both field and laboratory conditions. They are ideally suited for applications where lowest loss and good stability with bending are required.

Specifications:

Cable	AA number Stock Code	Conductor in (mm)	Dielectric in (mm)	Inner Shield in (mm)	InterLayer in (mm)	Outer Braid in (mm)	Jacket in (mm)	Weight lb/ft (kg/m)	Impedance ohms Vp (%)	Capacitance pF/ft (pF/m)	Temp. Range F (°C)	Min.Bend Radius in (mm)	Cut-off Frequency (GHz)
MG-130	AA-11521	SC	LDPTFE	SC	MT	SC	Blue FEP	0.018	50 +/-1	25.40	-67 +342	0.63	50.00
	510-0089	0.029 (0.74)	0.083 (2.11)	0.086 (2.18)	0.094 (2.39)	0.108 (2.74)	0.130 (3.30)	(0.027)	80%	(83.3)	(-55 +150)	(15.9)	
MG-160	AA-11258	SC	LDPTFE	SC	MT	SC	Blue FEP	0.026	50 +/-1	25.40	-67 +342	0.75	40.00
	510-0050	0.036 (0.91)	0.105 (2.67)	0.109 (2.77)	0.116 (2.95)	0.134 (3.40)	0.156 (3.96)	(0.038)	80%	(83.3)	(-55 +150)	(19.0)	
MG-200	AA-9889	SC	LDPTFE	SC	MT	SC	Blue FEP	0.037	50 +/-1	25.40	-67 +342	1.25	31.00
	510-0001	0.051 (1.29)	0.146 (3.71)	0.151 (3.84)	0.156 (3.96)	0.174 (4.42)	0.200 (5.00)	(0.051)	80%	(83.3)	(-55 +150)	(31.75)	
MG-300	AA-9857	SC	LDPTFE	SC	MT	SC	Blue FEP	0.093	50 +/-1	24.80	-67 +342	1.75	18.50
	510-0017	0.087 (2.21)	0.243 (6.17)	0.246 (6.25)	0.252 (6.40)	0.276 (7.01)	0.302 (7.67)	(0.139)	81%	(81.2)	(-55 +150)	(44.45)	

Attenuation vs. Frequency (Typical)

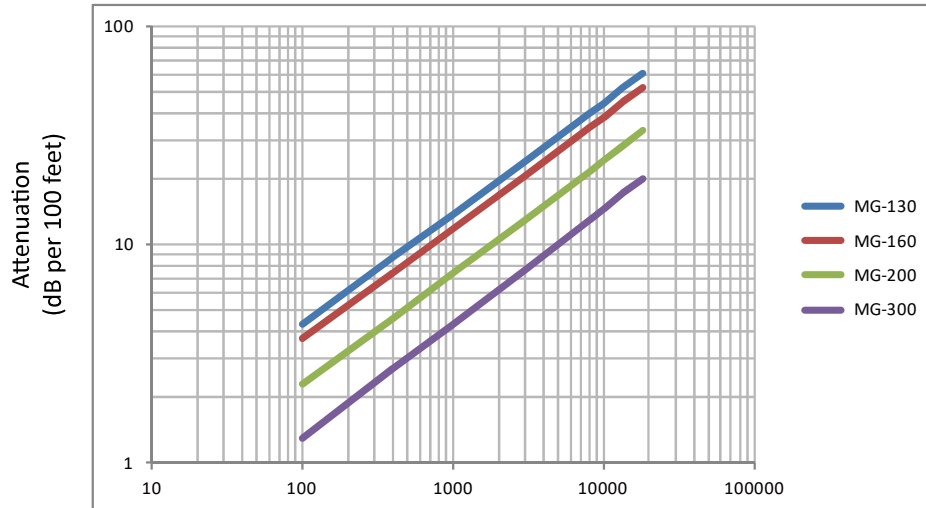

Frequency (MHz)	100	400	1,000	3,000	8,000	10,000	18,000	26,500	40,000	50,000
MG-130	4.3	8.7	13.8	24.0	39.8	44.6	60.6	74.3	92.5	104.3
MG-160	3.7	7.4	11.8	20.6	34.1	38.3	52.0	63.8	79.5	
MG-200	2.3	4.6	7.4	12.9	21.5	24.2	33.1	43.5		
MG-300	1.3	2.7	4.3	7.6	12.9	14.5	20.1			

Attenuation at Any Frequency = [k1 x SQRT (Fmhz)] + [k2 x Fmhz]; dB per 100 feet

Please consult factory for power handling data of the cable.

Connectors available for MaxGain cables

Cable	Interface	Description	Part Number	Stock Code	VSWR Freq. (GHz)	Coupling Nut	Length (mm)	Width (mm)	Weight (g)
MG-160	2.92MM Male	Straight	TC-MG160-KM-SS	3190-6116	<1.35:1 (40)	Hex	49.72	8.63	13.4
MG-200	N Male	Straight	TC-MG200-NMHC-LW-SS	3190-2790	<1.3:1 (18)	Hex	43.70	22.70	42.4
	SMA Male	Straight	TC-MG200-SMC-LW-SS	3190-2789	<1.3:1 (18)	Hex	39.50	10.50	16.1
MG-300	TNC Male	Straight	TC-MG200-TMC-LW-SS	3190-2830	<1.35:1 (18)	Hex	46.00	15.94	28.8
	N Male	Straight	TC-MG300-NMHC-LW-SS	3190-2715	<1.3:1 (18)	Hex	44.82	23.00	44.9
	SMA Male	Straight	TC-MG300-SMC-LW-SS	3190-2713	<1.35:1 (18)	Hex	42.45	14.50	24.5
	TNC Male	Straight	TC-MG300-TMC-LW-SS	3190-2714	<1.35:1 (18)	Hex	51.16	16.10	37.9

HeliFoil®

Features & Benefits:

- Lowest Insertion Loss Available, DC-18GHz
- Ultra Stable Loss, Phase and VSWR with Flexing
- Excellent Phase Tracking Performance over Temperature
- Extremely Flexible, Low Minimum Bend Radius
- Superior Shielding Effectiveness (>100 dB)

Flex Durability	Good
Attenuation	Very Low
Phase Temp. Stability	Very Good
Connector Availability	Good

HeliFoil® ultra low loss, flexible microwave coaxial cable and assemblies provide excellent performance over the DC-18 GHz frequency range. HeliFoil® cable comes in four different sizes, with options of stranded center conductors for better flexibility. All sizes provide lowest attenuation, excellent phase stability, broad operating temperature range and high power handling making them a good choice for interconnect and testing applications in both field and laboratory conditions.



Specifications:

Cable	AA number Stock Code	Conductor in (mm)	Dielectric in (mm)	Shields in (mm)	Outer braid in (mm)	Jacket in (mm)	Weight lb/ft (kg/m)	Impedance ohms Vp (%)	Capacitance pF/ft (pF/m)	Temp. Range F (C)	Min.Bend Radius in (mm)	Cut-off Frequency (GHz)
HF-090	AA-11892	SC	LDPTFE	SC	SC	Blue FEP	0.010	50 +/-1	24.6	-67 +342	0.38	80.80
	510-0145	0.020 0.51	0.056 1.42	0.063 1.60	0.077 1.96	0.087 2.21	(0.015)	80%	(80.7)	(-55 +150)	(9.65)	
HF-160	AA-11594	SC	LDPTFE	SC	SC	Blue FEP	0.025	50 +/-1	25.4	-67 +342	0.75	42.68
	510-0101	0.036 0.91	0.105 2.67	0.112 2.84	0.130 3.30	0.150 3.81	(0.038)	80%	(83.3)	(-55 +150)	(19.05)	
HF-190	AA-9185	SC	LDPTFE	SC	SC	Blue FEP	0.042	50 +/-1	24.0	-67 +342	1.00	31.25
	51881	0.054 1.37	0.145 3.68	0.158 4.01	0.175 4.45	0.197 5.00	(0.063)	81%	(78.7)	(-55 +150)	(25.4)	
HF-290	AA-9186	SC	LDPTFE	SC	SC	Blue FEP	0.092	50 +/-1	24.6	-67 +342	1.50	18.96
	51909	0.088 2.24	0.240 6.10	0.255 6.48	0.273 6.93	0.301 7.65	(0.138)	82%	(80.7)	(-55 +150)	(38.1)	

* PUR Jacket is available as an option, for detailed information please consult the factory.

HF-190 Phase Change vs. Temperature

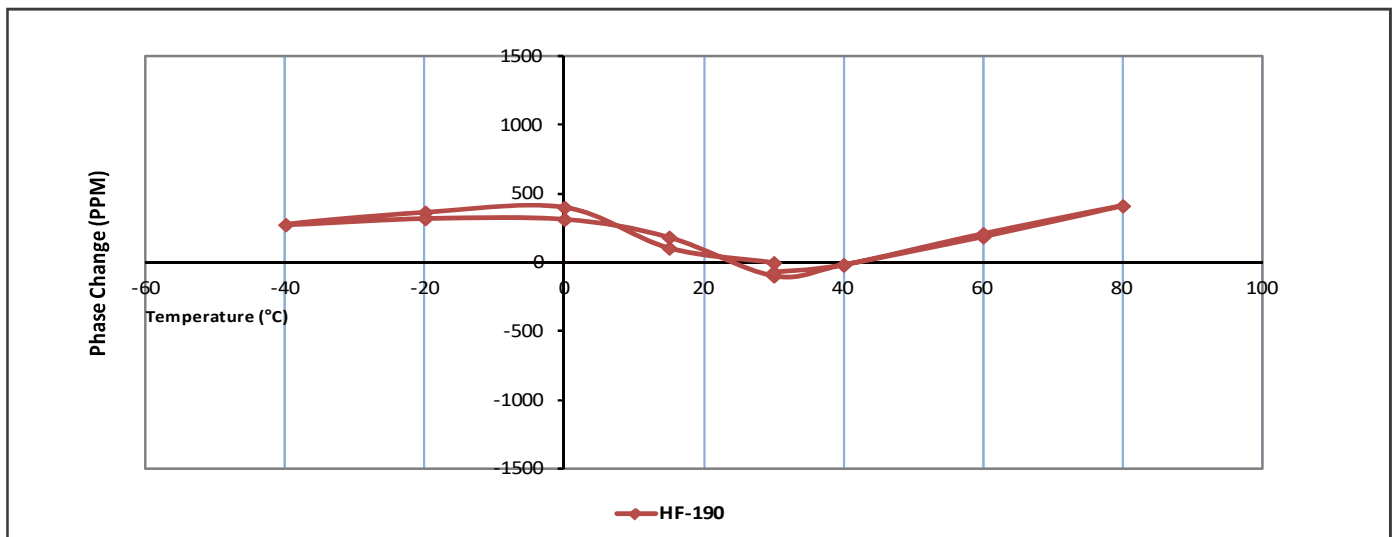

Attenuation vs. Frequency (Typical)

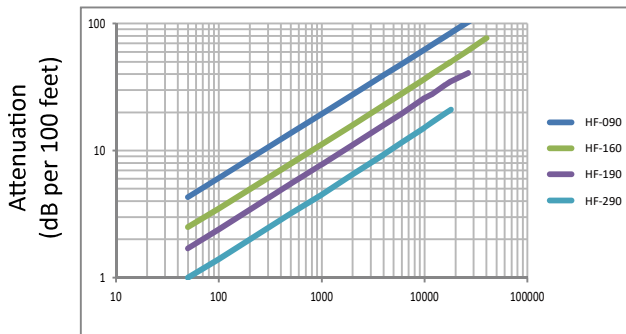

Power Handling vs. Frequency (Maximum)

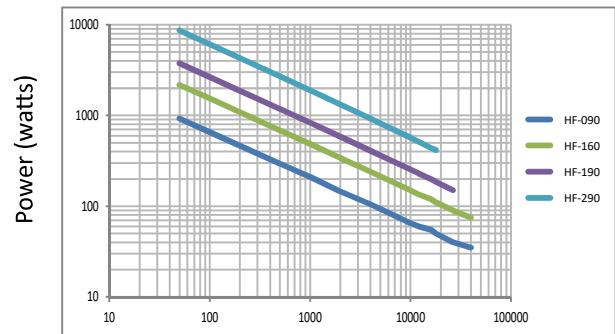

Frequency (MHz)	50	100	500	1,000	2,000	4,000	6,000	10,000	12,000	16,000	18,000	26,500	40,000
HF-090	4.3	6.1	13.7	19.5	27.6	39.2	48.1	62.5	68.6	79.5	84.4	103.1	127.6
HF-160	2.5	3.5	7.9	11.2	15.9	22.8	28.1	36.6	40.3	46.9	50.0	61.4	76.8
HF-190	1.7	2.4	5.5	7.8	11.1	15.9	19.6	26.0	28.0	33.0	35.0	40.9	
HF-290	1.0	1.4	3.2	4.5	6.5	9.3	11.6	15.2	16.8	19.7	21.0		

Attenuation at Any Frequency = [k1 x SQRT (Fmhz)] + [k2 x Fmhz]; dB per 100 feet

Frequency (MHz)	50	100	500	1,000	2,000	4,000	6,000	10,000	12,000	16,000	18,000	26,500	40,000
HF-090	930	655	295	210	145	105	85	65	60	55	50	40	35
HF-160	2175	1540	685	485	340	240	195	150	135	120	110	90	75
HF-190	3765	2660	1180	830	585	410	330	255	230	200	185	150	
HF-290	8645	6100	2700	1895	1325	925	745	570	515	440	415		

Power- Watts; Sea Level; Ambient +40 °C ; VSWR 1:1

Connectors available for HeliFoil cables

Cable	Interface	Description	Part Number	Stock Code	VSWR Freq. (GHz)	Coupling Nut	Length (mm)	Width (mm)	Weight (g)
HF-090	SMA Male	Straight	TC-090-SM-EF-SS	3190-6389	<1.3:1 (26.5)	Hex	17.00	9.24	6.3
	2.92MM Male	Straight	EZ-090-KM-SS	3190-6394	<1.35:1 (40)	Hex	25.26	9.24	10.1
HF-160	2.92MM Male	Straight	EZ-HF160-KM-SS	3190-6269	<1.35:1 (40)	Hex	49.69	9.24	13.4
HF-190	3.5MM Male	Straight	TC-190-35M-LW-SS	3190-6044	<1.3:1 (26.5)	Hex	34.99	10.50	15.4
	SMA Male	Straight	TC-190-SM-LW-SS	3190-2722	<1.3:1 (18)	Hex	33.05	10.30	13.8
	N Male	Straight	TC-190-NMH-LW-SS	3190-2710	<1.3:1 (18)	Hex	38.56	22.00	39.7
	TNC Male	Straight	TC-190-TM-LW-SS	3190-2723	<1.35:1 (18)	Hex	37.95	15.71	25.2
HF-290	SMA Male	Straight	TC-290-SM-SS	3190-2604	<1.3:1 (18)	Hex	36.20	14.50	19.0
	SMA Male	Right Angle	TC-290-SM-RA-SS	3190-6205	<1.35:1 (18)	Hex	63.93	20.38	27.7
	N Male	Straight	TC-290-NMH-LW-SS	3190-2605	<1.3:1 (18)	Hex	43.70	22.00	45.2
	N Male	Right Angle	TC-290-NM-RA-LW-SS	3190-6117	<1.35:1 (18)	Hex	48.10	31.43	71.4
	TNC Male	Straight	TC-290-TM-LW-SS	3190-2606	<1.35:1 (18)	Hex	44.00	15.71	34.7
	TNC Male	Right Angle	TC-290-TM-RA-LW-SS	3190-3001	<1.35:1 (18)	Hex	47.28	35.00	61.0

StripFlex®-II (SFT)



Features & Benefits

- Lower Loss than SF Versions
- Superior Shielding Effectiveness
- Low Passive Intermod (-155dBc)
- Stable Loss & VSWR vs. Flexing
- Excellent Connector Selection

SFT cable provides the ultimate performance in a flexible cable. The low density PTFE tape dielectric provides the lowest dielectric loss of any practical dielectric and silver plated conductors make these the ideal choice for microwave applications and other commercial and military interconnect systems.

The high temperature dielectric and jacket enable their use in high ambient temperature up to +200C. They have losses slightly smaller than their low temperature TCOM counterparts as well as high power handling capability.

The Shielding systems, pioneered by Times Microwave Systems in the mid-sixties, consists of an inner silver plated ribbon braid (FSC), a spirally applied and overlapped composite aluminum tape interlayer (Intl), and an overall silver plated round wire braid (SC). The flat ribbon shield affords approximately 30% lower loss and >95 dB shielding compared with the typical M17/RG round wire braided shield (40 to 60 dB).

Flex Durability	Very Good
Attenuation	Low
Phase Temp. Stability	Good
Connector Availability	Very Good

Standard M17/RG cables are shielded with high coverage single or double round wire braids. While these shields provide 40 dB and 60 dB shielding effectiveness respectively. They are not particularly stable (loss & VSWR) nor is the shielding adequate for today's sensitive wireless communications and microwave military/defense applications.

VSWR is lower since the flat ribbon can be applied over the dielectric much more uniformly than multi-end round wire braids. The VSWR and attenuation variation due to aging and flexure is substantially lower at all frequencies, and especially above 12 GHz. StripFlex-II cables are also available from Times that have been sweep tested for broadband VSWR and attenuation performance. Please contact the factory with your specific requirements.

A good selection of standard interface connectors (crimp or clamp style) are available. SFT cable can be purchased in bulk reels or as preterminated and tested assemblies.

Cable	AA number Stock Code	Conductor in (mm)	Dielectric in (mm)	Inner Shield in (mm)	Interlayer in (mm)	Outer Shield in (mm)	Jacket in (mm)	Weight lb/ft (kg/m)	Impedance ohms Vp (%)	Capacitance pF/ft (pF/m)	Temp. Range F (C)	Min.Bend Radius in (mm)	Cut-off Frequency (GHz)
SFT-316	AA-8649	SC	LDPTFE	FSC	Al/Kapton	SC	Blue FEP	0.018	50+/-1	26.7	-67 +392	0.50	62.95
	51743	0.023 (0.57)	0.068 (1.73)	0.078 (1.98)	0.083 (1.85)	0.096 (2.44)	0.120 (3.05)	(0.027)	76%	(87.6)	(-55 +200)	(12.7)	
SFT-142	AA-8650	SC	LDPTFE	FSC	Al/Kapton	SC	Blue FEP	0.036	50+/-1	26.7	-67 +392	0.75	35.40
	51742	0.040 (1.02)	0.121 (3.07)	0.131 (3.33)	0.136 (3.48)	0.158 (4.01)	0.180 (4.57)	(0.054)	76%	(87.6)	(-55 +200)	(19.1)	
SFT-205	AA-8651	SC	LDPTFE	FSC	Al/Kapton	SC	Blue FEP	0.042	50+/-1	26.7	-67 +392	1.00	27.84
	51802	0.051 (1.29)	0.154 (3.91)	0.164 (4.17)	0.169 (4.29)	0.187 (4.75)	0.205 (5.21)	(0.063)	76%	(87.6)	(-55 +200)	(25.4)	
SFT-304	AA-8652	SC	LDPTFE	FSC	Al/Kapton	SC	Blue FEP	0.067	50+/-1	26.7	-67 +392	1.25	23.09
	51807	0.062 (1.57)	0.185 (4.70)	0.195 (4.95)	0.200 (5.08)	0.227 (5.77)	0.250 (6.35)	(0.100)	76%	(87.6)	(-55 +200)	(31.8)	

Attenuation vs. Frequency (Typical)

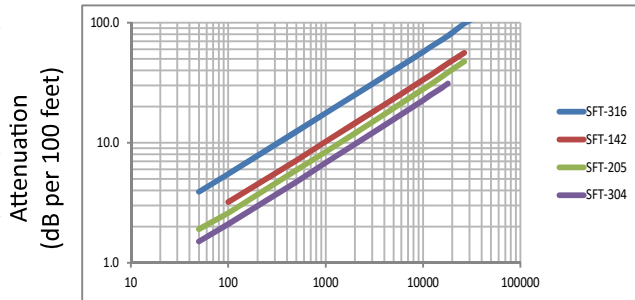

Power Handling vs. Frequency (Maximum)

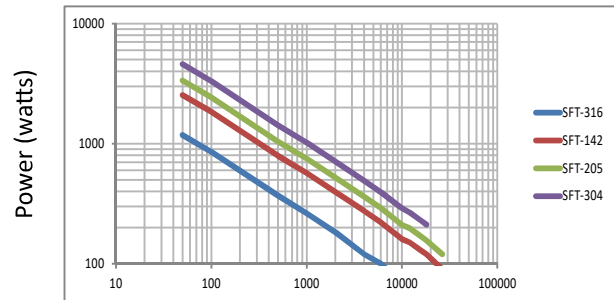

Frequency (MHz)	50	100	500	1,000	2,000	4,000	6,000	10,000	12,000	16,000	18,000	26,500	40,000
SFT-316	3.9	5.5	12.4	17.6	25.0	35.6	43.8	57.0	62.6	72.7	77.3	98.3	117.5
SFT-142	2.2	3.2	7.1	10.2	14.5	20.7	25.5	33.3	36.7	42.8	45.6	56.1	
SFT-205	1.9	2.6	5.9	8.4	12.0	17.2	21.3	27.9	30.7	36.0	38.3	47.3	
SFT-304	1.5	2.1	4.7	6.8	9.7	13.9	17.2	22.6	25	29	31.2		

Attenuation at Any Frequency = [k1 x SQRT (Fmhz)] + [k2 x Fmhz]; dB per 100 feet

Frequency (MHz)	50	100	500	1,000	2,000	4,000	6,000	10,000	12,000	16,000	18,000	26500	40,000
SFT-316	1180	854	370	263	183	120	100	70	69	58	54	40	30
SFT-142	2540	1843	790	569	397	275	221	160	151	128	120	90	
SFT-205	3360	2430	1040	750	523	362	291	210	198	168	157	120	
SFT-304	4590	3309	1420	1020	710	491	394	290	268	227	212		

Power- Watts; Sea Level; Ambient +40°C ; VSWR 1:1

Connectors available for SFT cables

Cable	Interface	Description	Part Number	Stock Code	VSWR Freq. (GHz)	Coupling Nut	Length (mm)	Width (mm)	Weight (g)
SFT-316	SMA Male	Straight	TC-316T-SM-SS	3190-2738	<1.3:1 (18)	Hex	28.37	9.00	9.8
	SMA Male	Right Angle	TC-316T-SM-RA-LW-SS	3190-2952	<1.35:1 (18)	Hex	34.09	18.24	15.8
SFT-142	SMA Male	Straight	TC-142T-SM-SS	3190-2793	<1.3:1 (18)	Hex	32.20	12.70	17.7
	SMA Male	Right Angle	EZ-142T-SM-RA-SS	3190-6315	<1.35:1 (26.5)	Hex	50.72	20.50	19.1
	N Male	Straight	TC-142T-NM-SS	3190-2794	<1.3:1 (18)	Hex	40.25	20.80	40.8
SFT-205	SMA Male	Straight	TC-205T-SM-LW-SS	3190-2289	<1.3:1 (18)	Hex	29.08	11.00	11.6
	SMA Male	Right Angle	TC-205T-SM-RA-LW-SS	3190-2733	<1.35:1 (18)	Hex	35.25	19.03	19.7
	N Male	Straight	TC-205T-NMH-LW-SS	3190-2291	<1.3:1 (18)	Hex	38.30	22.00	42.9
	TNC Male	Straight	TC-205T-TM-LW-SS	3190-2676	<1.35:1 (18)	Hex	38.20	15.71	27.9
	3.5MM Male	Straight	TC-205T-35M-SS	3190-2925	<1.3:1 (26.5)	Hex	35.18	10.50	14.4
SFT-304	SMA Male	Straight	TC-304T-SM-SS	3190-2288	<1.3:1 (18)	Hex	35.05	10.50	12.4
	N Male	Straight	TC-304T-NMH-LW-SS	3190-2290	<1.35:1 (18)	Hex	41.50	23.67	35.1
	TNC Male	Straight	TC-304T-TM-SS	3190-2584	<1.35:1 (18)	Hex	40.00	15.71	23.7



Features & Benefits

- Meets all MIL-DTL-17 Requirements
- Excellent Shielding Effectiveness
- Low Passive Intermod (PIM)
- Stable Loss, Phase, & VSWR vs Flexing
- Uses Standard Solder-on Semirigid Connectors

Flex Durability	Good
Attenuation	Medium
Phase Temp. Stability	Fair
Connector Availability	Very Good

TFlex® employs a thin helical wrap of silver plated copper tape and overall braid sized such that standard solder-on connectors can be used.

TFlex® was developed 10 years ago and have been widely adopted by the commercial and military OEM's.

Some of the key characteristics of TFlex® are:

Passive Intermod – typically >-150dBc (2x20 watt carriers)
Shielding Effectiveness – comparable to standard semirigid and like semirigid is beyond measurable limits.

Small/Lightweight – same size but lighter weight than standard CL semirigid coax.

Phase Stable – the helical tape outer conductor minimized electrical length change with temperature to yield substantial improvement over equivalent size flexible cables.

Low Loss – can achieve loss comparable to standard CL semirigid coax.

Attenuation Stability – silver plated outer conductor prevents oxidation of the conductors thereby minimizing attenuation change vs time.

Power Handling – comparable to standard CL semirigid.

Corrosion Resistance – jacketing of the cable with FEP provides excellent protection when cable is deployed in a corrosive environment.

Formability – the flexible nature of TFlex eliminates the need for hand or precision machine bending. TFlex is preterminated in it's approximate desired length and just "plugged in" using the most convenient/desirable routing.

Connectors (Solder-on) – are available from a variety of sources to fit standard semirigid coax and TFlex.

Specifications:

Cable	AA number Stock Code	Conductor in (mm)	Dielectric in (mm)	Shields in (mm)	Jacket in (mm)	Weight lb/ft (kg/m)	Impedance ohms Vp (%)	Capacitance pF/ft (pF/m)	Temp. Range F (C)	Min. Bend Radius in (mm)	Cut-off Frequency (GHz)
TFlex-405	AA-7741	SCCS	PTFE	SC	Blue FEP	0.015	50 +/-1	29.3	-85 +267	0.25	61.87
	51670	0.020 (0.51)	0.064 (1.63)	0.085 (2.16)	0.104 (2.64)	(0.022)	70%	(96.1)	(-65 +125)	(6.4)	
TFlex-402	AA-7740	SC	PTFE	SC	Blue FEP	0.033	50 +/-1	29.3	-85 +267	0.50	33.86
	51688	0.036 (0.91)	0.118 (3.00)	0.141 (3.58)	0.160 (4.06)	(0.049)	70%	(96.1)	(-65 +125)	(12.7)	
TFlex-401	AA-8642	SC	PTFE	SC	Blue FEP	0.095	50 +/-1	29.3	-85 +267	1.125	19.16
	51778	0.064 (1.63)	0.208 (5.28)	0.249 (6.32)	0.270 (6.9)	(0.142)	70%	(96.1)	(-65 +125)	(28.6)	

Attenuation vs. Frequency (Typical)

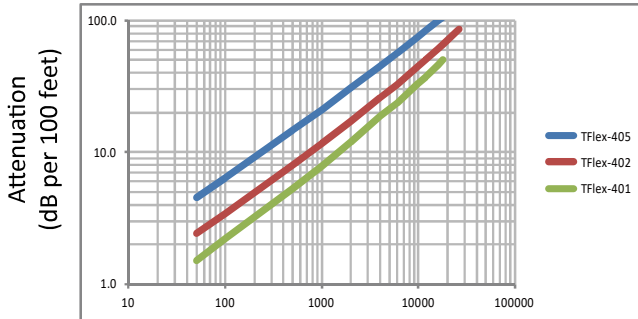

Power Handling vs. Frequency (Maximum)

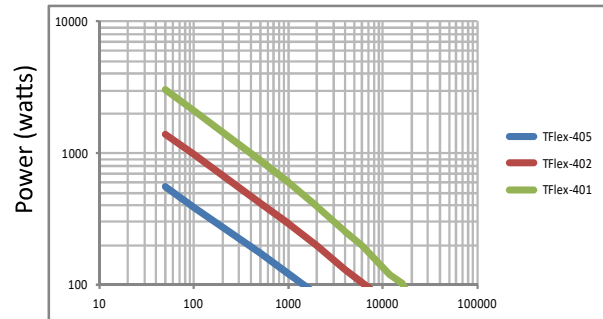

Frequency (MHz)	50	100	500	1,000	2,000	4,000	6,000	10,000	12,000	16,000	18,000	26,500	40,000
TFlex-405	4.5	6.4	14.7	21.1	30.5	44.6	56.0	75.0	83.4	98.9	106.1	134.4	174.0
TFlex-402	2.4	3.4	8.0	11.6	17.1	25.7	32.8	45.0	50.6	60.9	65.9	85.5	
TFlex-401	1.5	2.2	5.3	7.8	11.8	18.8	23.5	33.0	37.4	45.8	50.0		

Attenuation at Any Frequency = [k1 x SQRT (Fmhz)] + [k2 x Fmhz]; dB per 100 feet

Frequency (MHz)	50	100	500	1,000	2,000	4,000	6,000	10,000	12,000	16,000	18,000	26,500	40,000
TFlex-405	560	390	173	121	85	59	47	36	33	28	26	21	17
TFlex-402	1386	980	418	290	198	132	105	78	69	58	54	41	
TFlex-401	3010	2095	885	595	394	257	198	136	120	102	88		

Power- Watts; Sea Level; Ambient +40C ; VSWR 1:1

Connectors available for TFlex cables

Cable	Interface	Description	Part Number	Stock Code	VSWR Freq. (GHz)	Coupling Nut	Length (mm)	Width (mm)	Weight (g)
TFlex-402	SMA Male	Straight	TC-402-SM-EF-SS	3190-6248	<1.3:1 (26.5)	Hex	14.65	9.24	6.5
	SMA Male	Right Angle	EZ-402-SM-RA	3190-2902	<1.3:1 (18)	Hex	27.06	18.24	12.9
	N Male	Straight	TC-402-NMH	3190-2921	<1.3:1 (18)	Hex	33.88	22.00	35.6
TFlex-405	SMA Male	Straight	TC-405-SM-EF	3190-2711	<1.35:1 (26.5)	Hex	17.50	9.24	6.4
	SMA Male	Right Angle	TC-405-SM-RA	3190-2901	<1.35:1 (18)	Hex	26.06	17.77	14.0
	2.92MM Male	Straight	EZ-405-KM-SS	3190-6225	<1.3:1 (40)	Hex	23.16	9.24	8.4
	SMP Female	Straight	TC-405-SMPF	3190-6329	<1.5:1 (40)	NA	6.90	3.40	0.3
	MSMP Female	Straight	EZ-405-MSMPF	3190-6314	<1.5:1 (40)	NA	11.24	3.80	3.5
	2.92MM Female	Straight	EZ-405-KF-SS	3190-6309	<1.35:1 (40)	NA	15.57	9.24	5.8

Connectors

Times Microwave Systems designs and manufactures high performance RF and Microwave coaxial cables, connectors and cable assemblies for military, aerospace, telecommunications, compliance testing and industrial applications. We are an engineering organization committed to innovation and development of new products for demanding applications, but also a fully integrated manufacturer of cable, connectors and assemblies with cost effective production facilities and the resources of Amphenol behind us.

We offer a full range of connectors with all standard interfaces designed to match our microwave cables and provide optimum performance. Our integrated design and production expertise positions to provide custom cable assemblies to meet your requirements including phase matching, special testing, custom connectors, improved strain relief, armoring, special markings, traceability, color coding, kitting and other special requirements.



Swept option: Swept replaceable screw tube is available to satisfy the right angle requirement with an effective cost, while the performance could be maintained the same as the straight connectors.

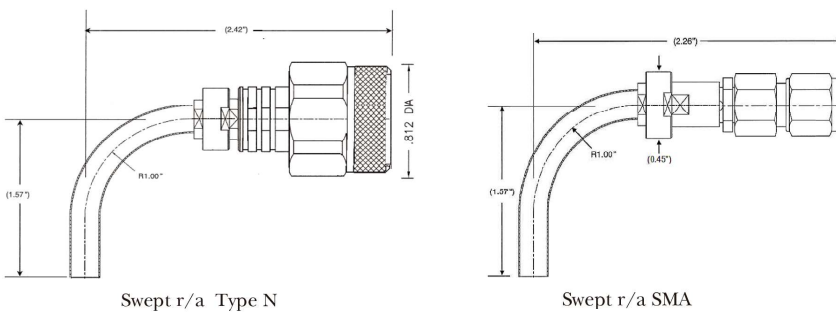

* Dimension is just for reference. For detailed information please contact factory.

Cable Assemblies

Times Microwave Systems also provides microwave cables as assemblies to meet a broad range of application requirements. We provide special testing, custom connectors, improved strain relief, special markings and other services to meet the requirements of your application.

Armored option: Steel armor is available as an option to provide the cable assembly the additional protection for rough field application.



Here is the list of swept and armor option for reference:

Connector \ Cable	MG-160	SFT-205	SFT-205-PUR	HF-190	HF-190-PUR	HF-290
3.5MM Male SW	—	3190-6156	3190-6158	3190-6108	3190-6104	—
SMA Male SW	—	3190-6089	3190-6086	3190-6105	3190-6101	—
N Male SW	—	3190-6090	3190-6087	3190-6106	3190-6102	—
TNC Male SW	—	3190-6091	3190-6088	3190-6107	3190-6103	—
Steel Armor Option	Available	Available	—	Available	—	Available

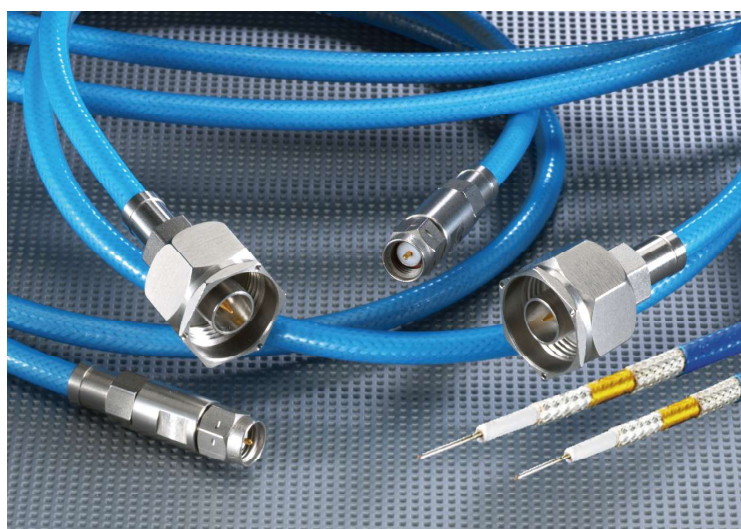

MISSION

TIMES MICROWAVE SYSTEMS designs and manufactures high performance RF and microwave transmission lines. These products consist of coaxial cables, connectors, accessories and cable assemblies.

We are committed to understanding the needs and requirements of our customers and providing highly engineered, cost effective products.

TIMES MICROWAVE SYSTEMS is dedicated to total customer satisfaction and superior results for our shareholders in all we do.



World Headquarters: 358 Hall Avenue, Wallingford, CT 06492 • Tel: 203-949-8400, 1-800-867-2629 Fax: 203-949-8423
China: Bld 4, No.318 Yuanshan Road, Shanghai, China 201108 • Tel: 86-21-51761234 Fax: 86-21-64424098
www.timesmicrowave.com